





# ASSEMBLY INSTRUCTION FOR ACME FURNITURE

MODEL#63000/#60000/#DN01351





MODEL#62000/#DN01346

Thank you for purchasing the quality product. Be sure to check all packing material carefully for small parts which may have come loose inside the carton during shipment. Separate, identify and count all parts and metal hardware. Compare with all parts list to be sure all parts are present. If any part(s) are missing or damaged, please contact your local furniture dealer. For efficient and speedy service, please indicate the model number and code letter of part(s) needed.

\*\*\* Do not fully tighten screws until fully assembled \*\*\*

COMPONENT PARTS		
"NO"	DESCRIPTION	QTY (PCS)
①	Table Top 	1
②	LEAF 	2
③	Table Base 	2
④	Table Pedestal 	2
⑤	Connecting Board 	2

## HARDWARE REQUIRED

Ⓐ		Bolt	Ø5/16"X3-1/4"	8	<b>PCS</b>
Ⓑ		Bolt	Ø5/16"X2"	16	<b>PCS</b>
Ⓒ		Lock Washer	Ø5/16"X12mm	24	<b>PCS</b>
Ⓓ		Flat Washer	Ø5/16"X22mm	24	<b>PCS</b>
Ⓔ		Allen Wrench	5mm	1	<b>PCS</b>

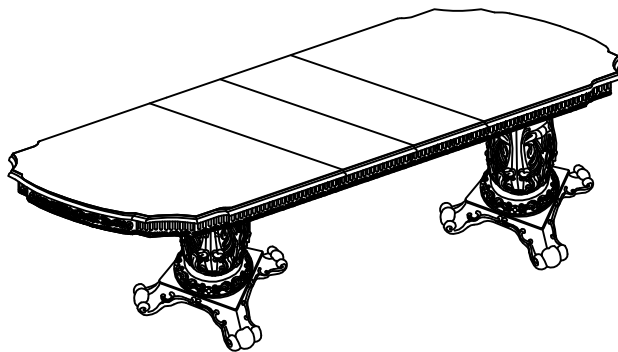

### Attention

\*\*\* Some number parts listed on the instruction sheet may not be in parts bag as they may already be assembled. Carefully check parts and packing materials prior to ordering replacements.

# How to assemble:

Step:1

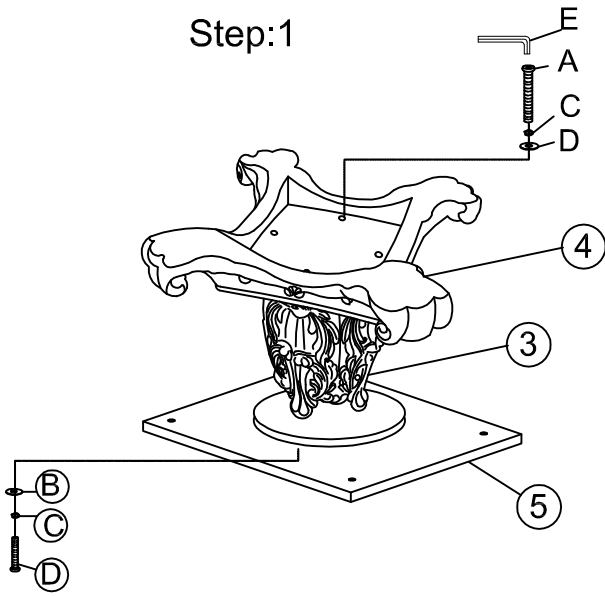

Step:2

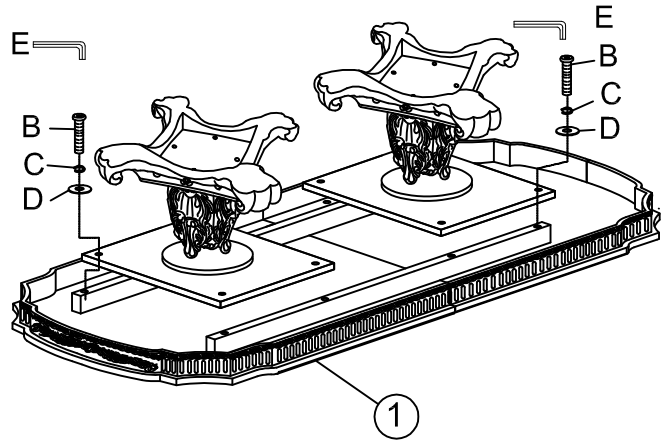

Step:3

